



LCD Module Technical Specification

First Edition
Sep 4, 2000

Final Revision

Type No. **DMC16230-AAE-DW**

Approved by (Production Div.)

Checked by (Quality Assurance Div.)

Checked by (Design Engineering Div.)

Prepared by (Production Div.)

Table of Contents

1. General Specifications.....	2
2. Electrical Specifications.....	3
3. Optical Specifications.....	5
4. I/O Terminal.....	7
5. Test.....	9
6. Appearance Standards.....	10
7. Code System of Production Lot.....	13
8. Type Number.....	13
9. Applying Precautions.....	13
10. Precautions Relating Product Handling.....	14
11. Warranty.....	15

Revision History

Rev.	Date	Page	Comment

1. General Specifications

Operating Temp.	:	min. 0°C ~ max. 50°C
Storage Temp.	:	min. -20°C ~ max. 70°C
Display Format	:	16 characters × 2 lines
Display Fonts	:	5 × 7 dots + cursor (1 character)
Viewing Area	:	99.0 (W) × 24.0 (H) mm
Outline Dimensions	:	122.0 (W) × 44.0 (H) × 11.0 max. (D) mm
Weight	:	60g max.
LCD Type	:	FRD-7136 (TN / Clear / Reflective)
Viewing Angle	:	6:00
Backlight	:	None
Drawings	:	Dimensional Outline UE-30327B

2. Electrical Specifications

2.1. Absolute Maximum Ratings

V_{SS}=0V

Parameter	Symbol	Conditions	Min.	Max.	Units
Supply Voltage (Logic)	V _{CC} -V _{SS}	-	-0.3	7.0	V
Supply Voltage (LCD Drive)	V _{CC} -V _{EE}	-	0	13.0	V
Input Voltage	V _I	-	-0.3	V _{CC} +0.3	V

2.2. DC Characteristics

T_a=25°C, V_{SS}=0V

Parameter	Symbol	Conditions	Min.	Typ.	Max.	Units
Supply Voltage (Logic)	V _{CC} -V _{SS}	-	4.5	-	5.5	V
Supply Voltage (LCD Drive)	V _{CC} -V _{EE}	Shown in 3.1				V
High Level Input Voltage	V _{IH}	V _{CC} =5.0V±10%	2.2	-	V _{CC}	V
Low Level Input Voltage	V _{IL}	V _{CC} =5.0V±10%	-0.3	-	0.6	V
High Level Output Voltage	V _{OH}	I _{OH} =-0.205mA	2.4	-	-	V
Low Level Output Voltage	V _{OL}	I _{OL} =1.2mA	-	-	0.4	V
Supply Current	I _{CC}	V _{CC} -V _{SS} =5.0V	-	1.5	5.0	mA

2.3.AC Characteristics

V_{CC}=5.0V±10%

Parameter	Symbol	Conditions	Min.	Max.	Units
Enable Cycle Time	t _{CYC}	Fig.1, 2	500	-	ns
Enable Pulse Width	PW _{EH}	Fig.1, 2	230	-	ns
Enable Rise/Fall Time	t _{Er} , t _{Ef}	Fig.1, 2	-	20	ns
Address Setup Time	t _{AS}	Fig.1, 2	40	-	ns
Address Hold Time	t _{AH}	Fig.1, 2	10	-	ns
Write Data Setup Time	t _{DSW}	Fig.1	80	-	ns
Write Data Hold Time	t _{DHW}	Fig.1	10	-	ns
Read Data Delay Time	t _{DDR}	Fig.2	-	160	ns
Read Data Hold Time	t _{DHR}	Fig.2	5	-	ns

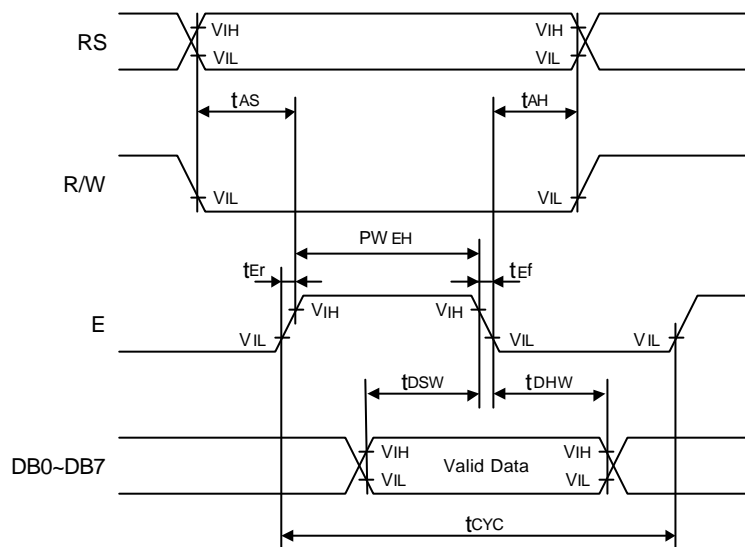

Fig.1 Write Operation Timing

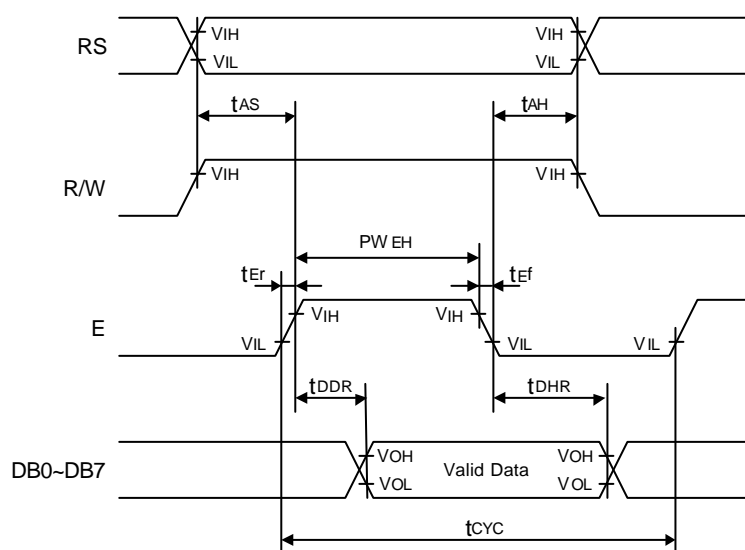

Fig.2 Read Operation Timing

3. Optical Specifications

3.1. LCD Driving Voltage

Parameter	Symbol	Conditions	Min.	Typ.	Max.	Units
Recommended LCD Driving Voltage Note 1	V _{CC} -V _{EE}	Ta= 0°C	-	-	5.0	V
		Ta=25°C	4.2	4.5	4.8	V
		Ta=50°C	3.6	-	-	V

Note 1 : Voltage (Applied actual waveform to LCD Module) for the best contrast. The range of minimum and maximum shows tolerance of the operating voltage. The specified contrast ratio and response time are not guaranteed over the entire range.

3.2. Optical Characteristics

Ta=25°C, 1/16 Duty, 1/5 Bias, V_D=4.5V (Note 4), θ=10°, φ=270°

Parameter	Symbol	Conditions	Min.	Typ.	Max.	Units
Contrast Ratio Note 1	CR	θ=20°, φ=270°	-	3.5	-	
Viewing Angle		Shown in 3.3				
Response Time	Rise Note 2	T _{ON}	-	180	270	ms
	Decay Note 3	T _{OFF}	-	130	200	ms

Note 1 : Contrast ratio is defined as follows.

$$CR = L_{OFF} / L_{ON} \quad CR = L_{ON} / L_{OFF}$$

L_{ON} : Luminance of the ON segments

L_{OFF} : Luminance of the OFF segments

Note 2 : The time that the luminance level reaches 90% of the saturation level from 0% when ON signal is applied.

Note 3 : The time that the luminance level reaches 10% of the saturation level from 100% when OFF signal is applied.

Note 4 : Definition of Driving Voltage V_D

Assuming that the typical driving waveforms shown below are applied to the LCD Panel at 1/A Duty - 1/B Bias (A : Duty Number, B : Bias Number). Driving voltage V_D is defined as follows.

$$V_D = (V_{th1} + V_{th2}) / 2$$

V_{th1} : The voltage V_{O-P} that should provide 50% of the saturation level in the luminance measured at θ= 10°, φ=270° on the segment which the ON signal is applied to.

V_{th2} : The voltage V_{O-P} that should provide 26% of the saturation level in the luminance measured at θ= 40°, φ=270° on the segment which the OFF signal is applied to.

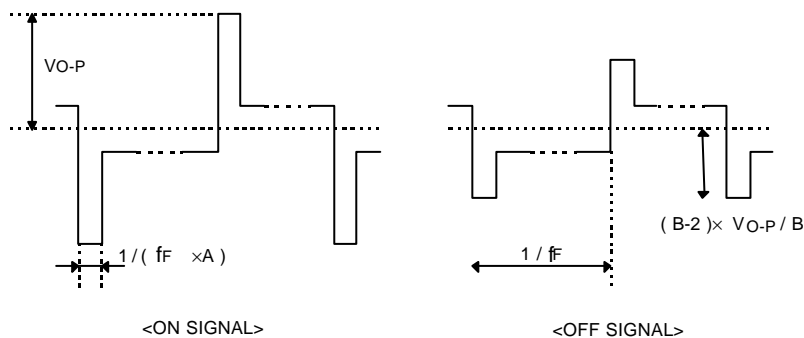

3.3. Definition of Viewing Angle and Optimum Viewing Area

*Point ● shows the point where contrast ratio is measured. : $\theta=20^\circ$, $\phi=270^\circ$

*Driving condition : 1/16 Duty, 1/5 Bias, $V_D=4.5V$, $f_F=84.4Hz$

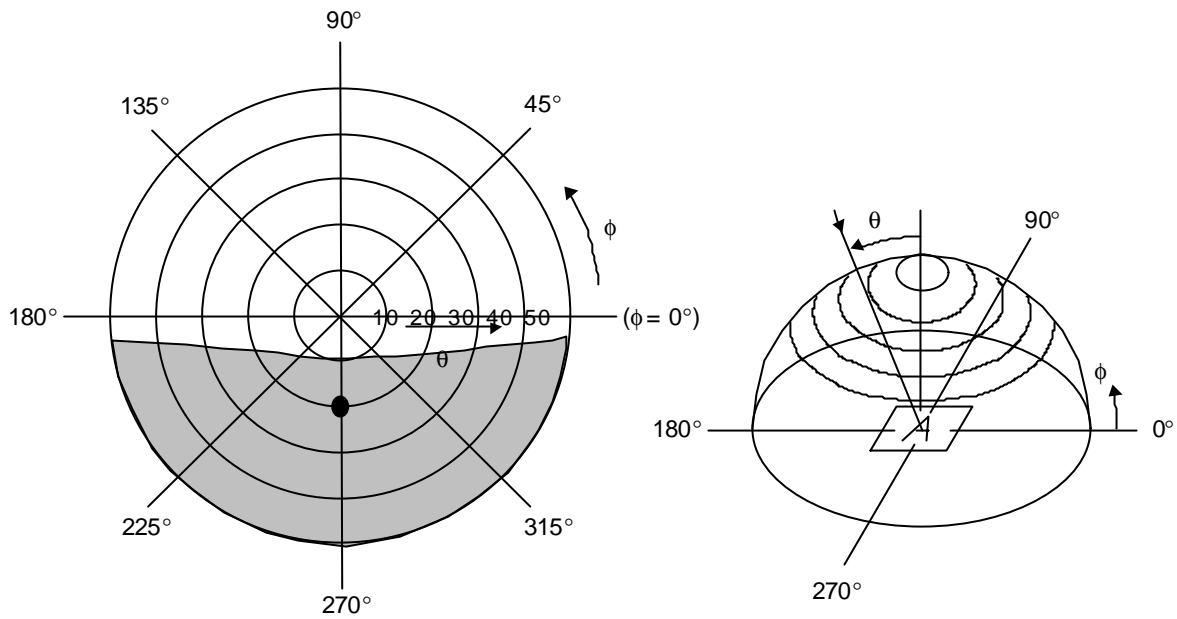

*Area  shows typ. $CR \geq 2$

3.4. System Block Diagram

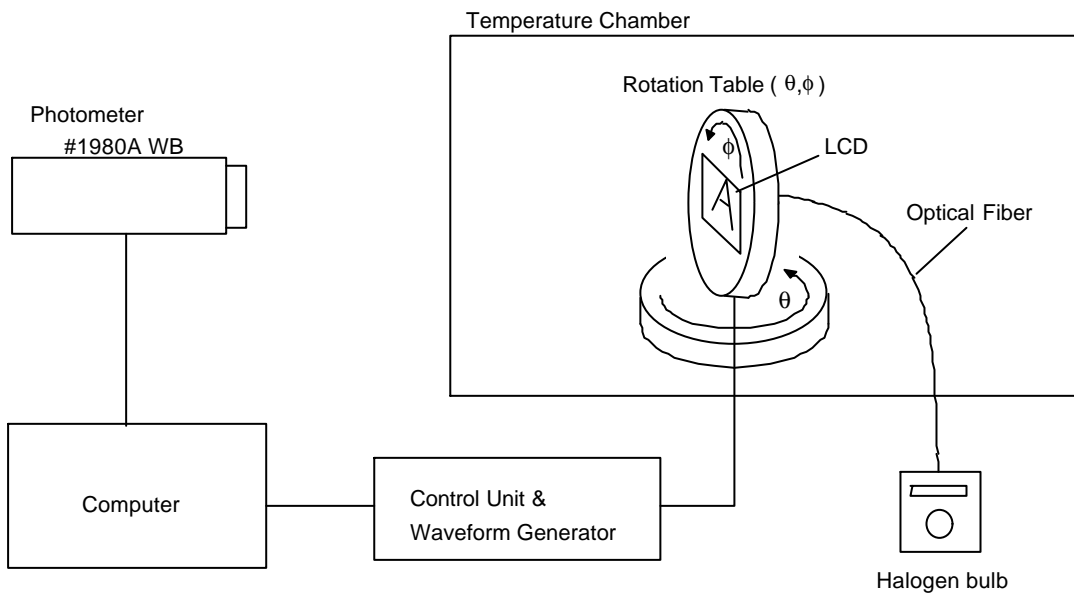

4.I/O Terminal

4.1.Pin Assignment

No.	Symbol	Level	Function
1.	V _{SS}	-	Power Supply (0V, GND)
2.	V _{CC}	-	Power Supply for Logic
3.	V _{EE}	-	Power Supply for LCD Drive
4.	RS	H / L	Register Select Signal
5.	R/W	H / L	Read/Write Select Signal H : Read L : Write
6.	E	H / L	Enable Signal (No pull-up Resister)
7.	DB0	H / L	Data Bus Line / Non-connection at 4-bit operation
8.	DB1	H / L	Data Bus Line / Non-connection at 4-bit operation
9.	DB2	H / L	Data Bus Line / Non-connection at 4-bit operation
10.	DB3	H / L	Data Bus Line / Non-connection at 4-bit operation
11.	DB4	H / L	Data Bus Line
12.	DB5	H / L	Data Bus Line
13.	DB6	H / L	Data Bus Line
14.	DB7	H / L	Data Bus Line

4.2.Example of Power Supply

It is recommended to apply a potentiometer for the contrast adjust due to the tolerance of the driving voltage and its temperature dependence.

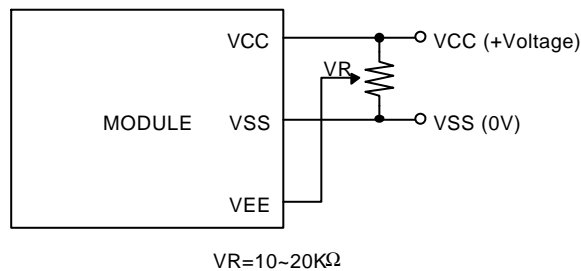

4.3. Block Diagram

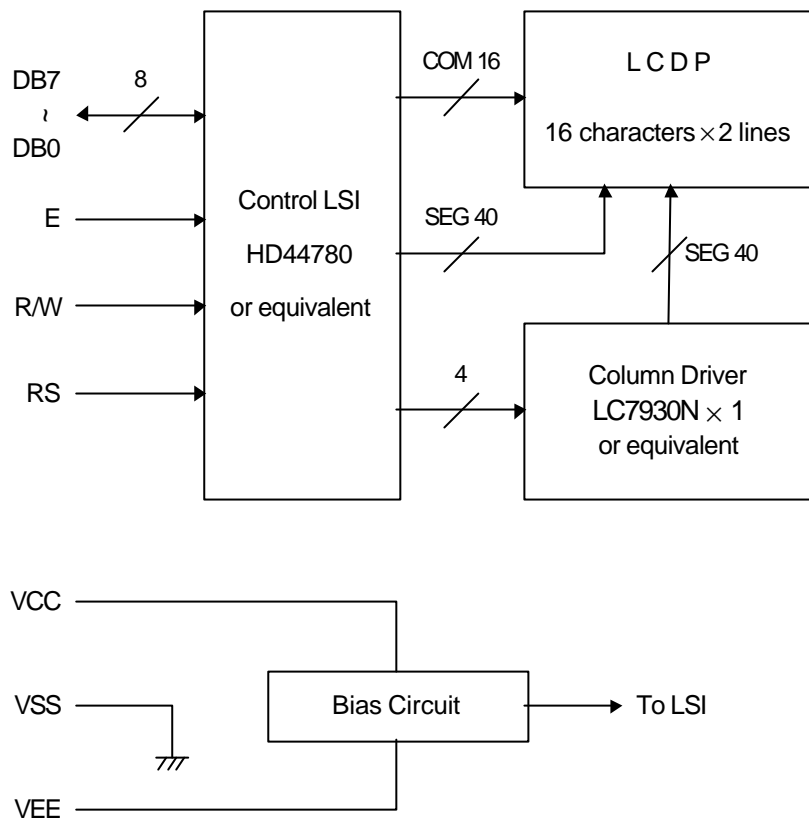

5. Test

No change on display and in operation under the following test condition.

Conditions: Unless otherwise specified, tests will be conducted under the following condition.

Temperature: $20 \pm 5^\circ\text{C}$

Humidity : $65 \pm 5\% \text{RH}$

tests will be not conducted under functioning state.

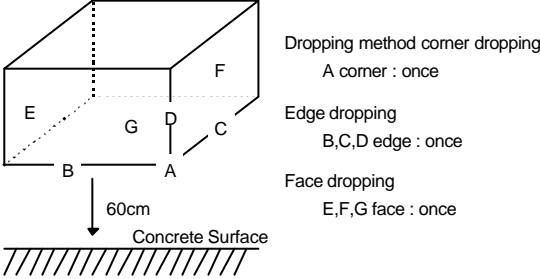
No.	Parameter	Conditions	Notes
1	High Temperature Operating	$50^\circ\text{C} \pm 2^\circ\text{C}$, 96hrs (operation state)	
2	Low Temperature Operating	$0^\circ\text{C} \pm 2^\circ\text{C}$, 96hrs (operation state)	1
3	High Temperature Storage	$70^\circ\text{C} \pm 2^\circ\text{C}$, 96hrs	2
4	Low Temperature Storage	$-20^\circ\text{C} \pm 2^\circ\text{C}$, 96hrs	1,2
5	Damp Proof Test	$40^\circ\text{C} \pm 2^\circ\text{C}$, 90~95%RH, 96hrs	1,2
6	Vibration Test	Total fixed amplitude : 1.5mm Vibration Frequency : 10~55Hz One cycle 60 seconds to 3 directions of X, Y, Z for each 15 minutes	3
7	Shock Test	To be measured after dropping from 60cm high on the concrete surface in packing state. 	

Note 1 :No dew condensation to be observed.

Note 2 :The function test shall be conducted after 4 hours storage at the normal Temperature and humidity after removed from the test chamber.

Note 3 :Vibration test will be conducted to the product itself without putting it in a container.

6.Appearance Standards

6.1.Inspection conditions

The LCD shall be inspected under 40W white fluorescent light.

The distance between the eyes and the sample shall be more than 30cm.

All directions for inspecting the sample should be within 45°against perpendicular line.

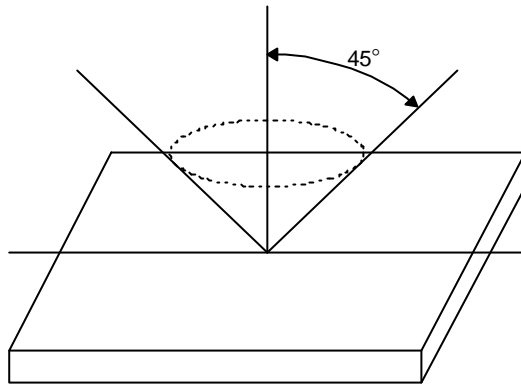

6.2.Definition of applicable Zones

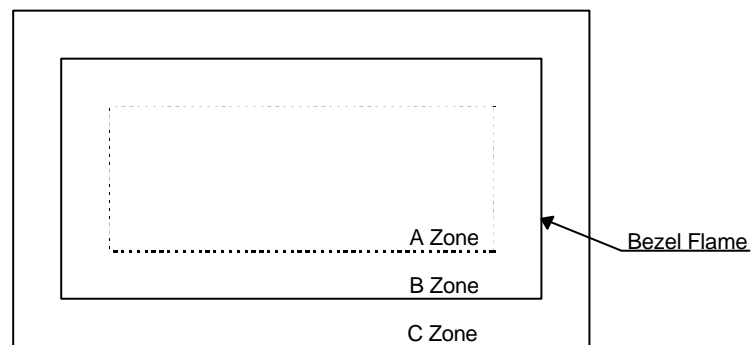

A Zone : Active display area

B Zone : Area from outside of "A Zone" to validity viewing area

C Zone : Rest parts

A Zone + B Zone = Validity viewing area

6.3. Standards

No.	Parameter	Criteria																																																											
1	Black and White Spots, Foreign Substances	<p>(1) Round Shape</p> <table border="1" data-bbox="603 322 1366 611"> <thead> <tr> <th data-bbox="603 322 906 369">Zone</th> <th colspan="3" data-bbox="906 322 1366 369">Acceptable Number</th> </tr> <tr> <th data-bbox="603 369 906 416">Dimension (mm)</th> <th data-bbox="906 369 1062 416">A</th> <th data-bbox="1062 369 1219 416">B</th> <th data-bbox="1219 369 1366 416">C</th> </tr> </thead> <tbody> <tr> <td data-bbox="603 416 906 463">$D \leq 0.1$</td> <td data-bbox="906 416 1062 463">*</td> <td data-bbox="1062 416 1219 463">*</td> <td data-bbox="1219 416 1366 463">*</td> </tr> <tr> <td data-bbox="603 463 906 510">$0.1 < D \leq 0.2$</td> <td data-bbox="906 463 1062 510">5</td> <td data-bbox="1062 463 1219 510">5</td> <td data-bbox="1219 463 1366 510">*</td> </tr> <tr> <td data-bbox="603 510 906 557">$0.2 < D \leq 0.3$</td> <td data-bbox="906 510 1062 557">0</td> <td data-bbox="1062 510 1219 557">1</td> <td data-bbox="1219 510 1366 557">*</td> </tr> <tr> <td data-bbox="603 557 906 611">$0.3 < D$</td> <td data-bbox="906 557 1062 611">0</td> <td data-bbox="1062 557 1219 611">0</td> <td data-bbox="1219 557 1366 611">*</td> </tr> </tbody> </table> <p data-bbox="603 622 1075 658">$D = (\text{Long} + \text{Short}) / 2$ * : Disregard</p> <p>(2) Line Shape</p> <table border="1" data-bbox="603 703 1366 1041"> <thead> <tr> <th colspan="2" data-bbox="603 703 906 750">Zone</th> <th colspan="3" data-bbox="906 703 1366 750">Acceptable Number</th> </tr> <tr> <th data-bbox="603 750 759 797">X(mm)</th> <th data-bbox="759 750 906 797">Y(mm)</th> <th data-bbox="906 750 1062 797">A</th> <th data-bbox="1062 750 1219 797">B</th> <th data-bbox="1219 750 1366 797">C</th> </tr> </thead> <tbody> <tr> <td data-bbox="603 797 759 844">-</td> <td data-bbox="759 797 906 844">$0.02 \geq W$</td> <td data-bbox="906 797 1062 844">*</td> <td data-bbox="1062 797 1219 844">*</td> <td data-bbox="1219 797 1366 844">*</td> </tr> <tr> <td data-bbox="603 844 759 891">$2.0 \geq L$</td> <td data-bbox="759 844 906 891">$0.03 \geq W$</td> <td data-bbox="906 844 1062 891">3</td> <td data-bbox="1062 844 1219 891">3</td> <td data-bbox="1219 844 1366 891">*</td> </tr> <tr> <td data-bbox="603 891 759 938">$1.0 \geq L$</td> <td data-bbox="759 891 906 938">$0.04 \geq W$</td> <td data-bbox="906 891 1062 938">1</td> <td data-bbox="1062 891 1219 938">2</td> <td data-bbox="1219 891 1366 938">*</td> </tr> <tr> <td data-bbox="603 938 759 985">$1.0 \geq L$</td> <td data-bbox="759 938 906 985">$0.05 \geq W$</td> <td data-bbox="906 938 1062 985">0</td> <td data-bbox="1062 938 1219 985">2</td> <td data-bbox="1219 938 1366 985">*</td> </tr> <tr> <td data-bbox="603 985 759 1041">-</td> <td data-bbox="759 985 906 1041">$0.05 < W$</td> <td colspan="3" data-bbox="906 985 1366 1041">In the same way (1)</td> </tr> </tbody> </table> <p data-bbox="603 1052 1046 1088">X : Length Y : Width * : Disregard</p> <p data-bbox="584 1099 963 1135">Total defects shall not exceed 5.</p>	Zone	Acceptable Number			Dimension (mm)	A	B	C	$D \leq 0.1$	*	*	*	$0.1 < D \leq 0.2$	5	5	*	$0.2 < D \leq 0.3$	0	1	*	$0.3 < D$	0	0	*	Zone		Acceptable Number			X(mm)	Y(mm)	A	B	C	-	$0.02 \geq W$	*	*	*	$2.0 \geq L$	$0.03 \geq W$	3	3	*	$1.0 \geq L$	$0.04 \geq W$	1	2	*	$1.0 \geq L$	$0.05 \geq W$	0	2	*	-	$0.05 < W$	In the same way (1)		
Zone	Acceptable Number																																																												
Dimension (mm)	A	B	C																																																										
$D \leq 0.1$	*	*	*																																																										
$0.1 < D \leq 0.2$	5	5	*																																																										
$0.2 < D \leq 0.3$	0	1	*																																																										
$0.3 < D$	0	0	*																																																										
Zone		Acceptable Number																																																											
X(mm)	Y(mm)	A	B	C																																																									
-	$0.02 \geq W$	*	*	*																																																									
$2.0 \geq L$	$0.03 \geq W$	3	3	*																																																									
$1.0 \geq L$	$0.04 \geq W$	1	2	*																																																									
$1.0 \geq L$	$0.05 \geq W$	0	2	*																																																									
-	$0.05 < W$	In the same way (1)																																																											
2	Air Bubbles (between glass & polarizer)	<table border="1" data-bbox="603 1182 1366 1471"> <thead> <tr> <th data-bbox="603 1182 906 1229">Zone</th> <th colspan="3" data-bbox="906 1182 1366 1229">Acceptable Number</th> </tr> <tr> <th data-bbox="603 1229 906 1276">Dimension (mm)</th> <th data-bbox="906 1229 1062 1276">A</th> <th data-bbox="1062 1229 1219 1276">B</th> <th data-bbox="1219 1229 1366 1276">C</th> </tr> </thead> <tbody> <tr> <td data-bbox="603 1276 906 1323">$D \leq 0.15$</td> <td data-bbox="906 1276 1062 1323">*</td> <td data-bbox="1062 1276 1219 1323">*</td> <td data-bbox="1219 1276 1366 1323">*</td> </tr> <tr> <td data-bbox="603 1323 906 1370">$0.15 < D \leq 0.3$</td> <td data-bbox="906 1323 1062 1370">2</td> <td data-bbox="1062 1323 1219 1370">3</td> <td data-bbox="1219 1323 1366 1370">*</td> </tr> <tr> <td data-bbox="603 1370 906 1417">$0.3 < D \leq 0.5$</td> <td data-bbox="906 1370 1062 1417">1</td> <td data-bbox="1062 1370 1219 1417">2</td> <td data-bbox="1219 1370 1366 1417">*</td> </tr> <tr> <td data-bbox="603 1417 906 1471">$0.5 < D \leq 1.0$</td> <td data-bbox="906 1417 1062 1471">0</td> <td data-bbox="1062 1417 1219 1471">1</td> <td data-bbox="1219 1417 1366 1471">*</td> </tr> </tbody> </table> <p data-bbox="603 1482 772 1518">* : Disregard</p> <p data-bbox="584 1529 963 1565">Total defects shall not exceed 3.</p>	Zone	Acceptable Number			Dimension (mm)	A	B	C	$D \leq 0.15$	*	*	*	$0.15 < D \leq 0.3$	2	3	*	$0.3 < D \leq 0.5$	1	2	*	$0.5 < D \leq 1.0$	0	1	*																																			
Zone	Acceptable Number																																																												
Dimension (mm)	A	B	C																																																										
$D \leq 0.15$	*	*	*																																																										
$0.15 < D \leq 0.3$	2	3	*																																																										
$0.3 < D \leq 0.5$	1	2	*																																																										
$0.5 < D \leq 1.0$	0	1	*																																																										

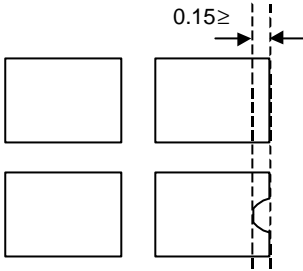
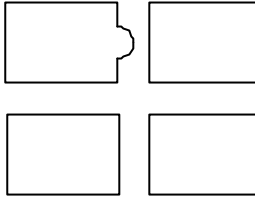
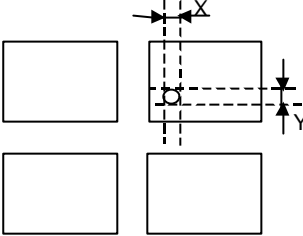
No.	Parameter	Criteria
3	The Shape of Dot	<p>(1) Dot Shape (with Dent)</p>  <p>As per the sketch of left hand.</p> <p>(2) Dot Shape (with Projection)</p>  <p>Should not be connected to next dot.</p> <p>(3) Pin Hole</p>  <p>$(X+Y) / 2 \leq 0.2\text{mm}$ (Less than 0.1mm is no counted.)</p> <p>Total defects shall not exceed 5.</p>
4	Polarizer Scratches	Not to be conspicuous defects.
5	Polarizer Dirts	If the stains are removed easily from LCDP surface, the module is not defective.
6	Color Variation	Not to be conspicuous defects.

7.Code System of Production Lot

The production lot of module is specified as follows.

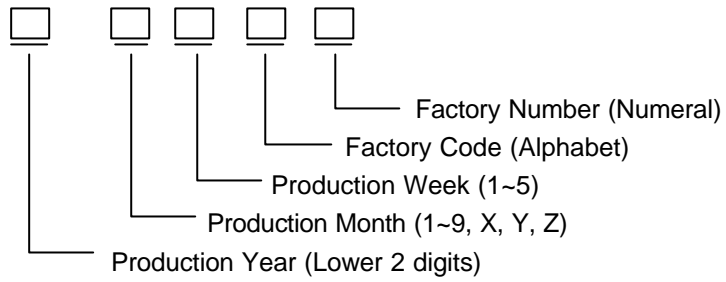

8.Type Number

The type number of module is specified on the back of module as follows.

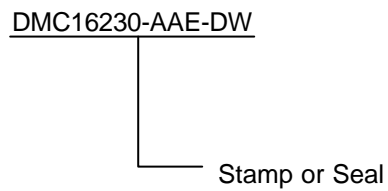

9.Applying Precautions

Please contact us when questions and/or new problems not specified in this specifications arise.

10. Precautions Relating Product Handling

The Following precautions will guide you in handling our product correctly.

- 1) Liquid crystal display devices
 1. The liquid crystal display device panel used in the liquid crystal display module is made of plate glass. Avoid any strong mechanical shock. Should the glass break handle it with care.
 2. The polarizer adhering to the surface of the LCD is made of a soft material. Guard against scratching it.
- 2) Care of the liquid crystal display module against static electricity discharge.
 1. When working with the module, be sure to ground your body and any electrical equipment you may be using. We strongly recommend the use of anti static mats (made of rubber), to protect work tables against the hazards of electrical shock.
 2. Avoid the use of work clothing made of synthetic fibers. We recommend cotton clothing or other conductivity-treated fibers.
 3. Slowly and carefully remove the protective film from the LCD module, since this operation can generate static electricity.
- 3) When the LCD module alone must be stored for long periods of time:
 1. Protect the modules from high temperature and humidity.
 2. Keep the modules out of direct sunlight or direct exposure to ultraviolet rays.
 3. Protect the modules from excessive external forces.
- 4) Use the module with a power supply that is equipped with an overcurrent protector circuit, since the module is not provided with this protective feature.
- 5) Do not ingest the LCD fluid itself should it leak out of a damaged LCD module. Should hands or clothing come in contact with LCD fluid, wash immediately with soap.
- 6) Conductivity is not guaranteed for models that use metal holders where solder connections between the metal holder and the PCB are not used. Please contact us to discuss appropriate ways to assure conductivity.
- 7) For models which use CFL:
 1. High voltage of 1000V or greater is applied to the CFL cable connector area. Care should be taken not to touch connection areas to avoid burns.
 2. Protect CFL cables from rubbing against the unit and thus causing the wire jacket to become worn.
 3. The use of CFLs for extended periods of time at low temperatures will significantly shorten their service life.
- 8) For models which use touch panels:
 1. Do not stack up modules since they can be damaged by components on neighboring modules.
 2. Do not place heavy objects on top of the product. This could cause glass breakage.
- 9) For models which use COG, TAB, or COF:
 1. The mechanical strength of the product is low since the IC chip faces out unprotected from the rear. Be sure to protect the rear of the IC chip from external forces.
 2. Given the fact that the rear of the IC chip is left exposed, in order to protect the unit from electrical damage, avoid installation configurations in which the rear of the IC chip runs the risk of making any electrical contact.

10) Models which use flexible cable, heat seal, or TAB:

1. In order to maintain reliability, do not touch or hold by the connector area.
2. Avoid any bending, pulling, or other excessive force, which can result in broken connections.

11) In case of buffer material such as cushion / gasket is assembled into LCD module, it may have an adverse effect on connecting parts (LCD panel-TCP / HEAT SEAL / FPC / etc., PCB-TCP / HEAT SEAL / FPC etc., TCP-HEAT SEAL, TCP-FPC, HEAT SEAL-FPC, etc.,) depending on its materials.

Please check and evaluate these materials carefully before use.

12) In case of acrylic plate is attached to front side of LCD panel, cloudiness (very small cracks) can occur on acrylic plate, being influenced by some components generated from polarizer film.. Please check and evaluate those acrylic materials carefully before use.

11. Warranty

This product has been manufactured to your company's specifications as a part for use in your company's general electronic products. It is guaranteed to perform according to delivery specifications. For any other use apart from general electronic equipment, we cannot take responsibility if the product is used in medical devices, nuclear power control equipment, aerospace equipment, fire and security systems, or any other applications in which there is a direct risk to human life and where extremely high levels of reliability are required. If the product is to be used in any of the above applications, we will need to enter into a separate product liability agreement.

1. We cannot accept responsibility for any defect, which may arise from additional manufacturing of the product (including disassembly and reassembly), after product delivery.
2. We cannot accept responsibility for any defect, which may arise after the application of strong external force to the product.
3. We cannot accept responsibility for any defect, which may arise due to the application of static electricity after the product has passed your company's acceptance inspection procedures.
4. When the product is in CFL models, CFL service life and brightness will vary according to the performance of the inverter used, leaks, etc. We cannot accept responsibility for product performance, reliability, or defect, which may arise.
5. We cannot accept responsibility for intellectual property of a third party, which may arise through the application of our product to your assembly with exception to those issues relating directly to the structure or method of manufacturing of our product.
6. Optrex will not be held responsible for any quality guarantee issue for defect products judged as Optrex-origin longer than 2 (two) years from Optrex production or 1(one) year from Optrex, Optrex America, Optrex Europe, Display LC delivery which ever comes later.